

SINGER
246-31

LIST OF PARTS COMPLETE

FOR

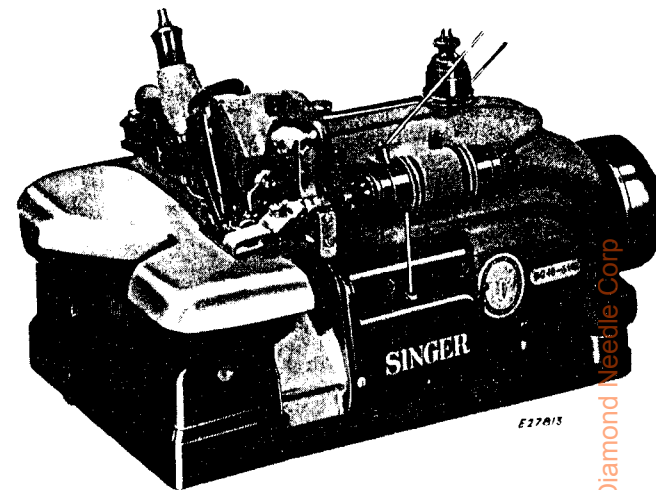

MACHINE NO. 246-31

FOR TRIMMING, OVEREDGING, AND BLIND STITCH HEMMING OR WELTING, NYLON, RAYON, KNIT GOODS AND OTHER FABRICS, ONE NEEDLE, ONE LOOPER. TWO THREAD OVEREDGE STITCH GATHERING (DIFFERENTIAL) FEED. TRIMMER

From the library of: Diamond Needle Corp

No.	Plate	Name
164234	24899	Blind Stitch Hemming Attachment Adjusting Slide (cylindrical)
140456K	24899	Blind Stitch Hemming Attachment Adjusting Thumb Screw
140457J	24899	Blind Stitch Hemming Attachment Adjusting Thumb Screw Locking Screw
160376	24899	Blind Stitch Hemming Attachment Folder for 1/2 in. to 2 in. Hem, in steps of 1/8 in.
NOTE: When ordering No. 160376, size of Hem required must be stated.		
160377	24899	Blind Stitch Hemming Attachment Folder Hinge
160378	24899	Blind Stitch Hemming Attachment Folder Hinge Bracket with 904AL
59480	24899	Blind Stitch Hemming Attachment Folder Hinge Pin

No.	Plate	Name
904AL	-----	Blind Stitch Hemming Attachment Folder Hinge Pin Set Screw
160574	-----	Blind Stitch Hemming Attachment Folder Holder complete, Nos. 335J, 1628K, 59480, 160377, 160378, 160379 and 160380
160379	24899	Blind Stitch Hemming Attachment Folder Screw Stud
1628K	24899	Blind Stitch Hemming Attachment Folder Screw Stud Nut
160380	24899	Blind Stitch Hemming Attachment Folder Stop Plate
335J	24899	Blind Stitch Hemming Attachment Folder Stop Plate Screw
164235	24899	Blind Stitch Hemming Attachment Hinge Bracket
164236	24899	Blind Stitch Hemming Attachment Support
164237	24899	Blind Stitch Hemming Attachment Support complete, Nos. 140456K, 140457J, 140458C, 164234, 164235, 164236 and 164238
164238	24899	Blind Stitch Hemming Attachment Support Cap
1259AL	24829	Blind Stitch Hemming Attachment Support Screw
160381	24899	Blind Stitch Hemming Attachment (with Folder) complete, for General Work, for 1/2 in. to 2 in. Hem, in steps of 1/8 in., Nos. 160376 and 160574
		NOTE: When ordering No. 160381, size of Hem required must be stated.
140458C	24899	Blind Stitch Hemming Attachment Thumb Screw
164862	24900	Chain Cutter complete, Nos. 665J, 164860 and 164861
164860	24900	Chain Cutter Holder
164861	24900	Chain Cutter Knife
665J	24900	Chain Cutter Knife Screw
51362AL	24900	Chain Cutter Screw (2)
164001	24901	Chip Guard
1209J	24901	Chip Guard Screw (lower)
140509J	24901	Chip Guard Screw (upper)
164512	24901	Cloth Plate Extension
51408J	24901	Cloth Plate Extension Screw (back)
1700J	24901	Cloth Plate Extension Screw Nut
931084	24901	Cloth Plate Extension Screw Nut Lock Washer
164205	24901	Cloth Plate Lock Spring
1700J	24901	Cloth Plate Lock Spring Nut
931084	24901	Cloth Plate Lock Spring Nut Lock Washer

No.	Plate	Name
1250AL	24901	Cloth Plate Lock Spring Screw Stud
164104	24901	Cloth Plate Plunger
164105	24901	Cloth Plate Plunger Spring
624AL	24901	Cloth Plate Plunger Set Screw
164106	24901	Cloth Plate Position Collar with two 624AL
624AL	24901	Cloth Plate Position Collar Set Screw (2)
164858	24901	Cloth Plate Support
1083J	24901	Cloth Plate Support Screw
164832	24901	Cloth Plate
164833	24901	Cloth Plate with Extension complete, Nos. 1083J, 51408J, 164205, 164512, 164832, 164858 and two each 1700J and 931084
161201	24899	Edge Guide (floating)
95XC	24899	Edge Guide (floating) Hinge Screw
140810X	24899	Edge Guide (floating) Regulating Thumb Screw
161202	-----	Edge Guide (floating) Regulating Thumb Screw Locking Insert (Brass)
904AL	24899	Edge Guide (floating) Regulating Thumb Screw Locking Insert Set Screw
160395	24899	Edge Guide (floating) Spring
51220AL	24899	Edge Guide (floating) Spring Screw
1607X	24899	Edge Guide (floating) Spring Screw Nut
161203	24899	Edge Guide (floating) and Edge Guide Support and Throat Plate Guide Bracket with 904AL
161204	-----	Edge Guide (floating) and Edge Guide Support and Throat Plate Guide Bracket 161203 with 140810X and 161202
161205	24899	Edge Guide (floating) and Edge Guide Support and Throat Plate Guide Bracket complete, Nos. 95XC, 198XC, 1607X, 51220AL, 160395, 161201, 161204 and 161206
997X	24899	Edge Guide (floating) and Edge Guide Support and Throat Plate Guide Bracket Screw
161206	24899	Edge Guide Support and Throat Plate Guide
198XC	24899	Edge Guide Support and Throat Plate Guide Screw
164003	24902	Feed Bar Hinge Pin (eccentric)
1389AL	24902	Feed Bar Hinge Pin Set Screw
164004	24902	Feed Bar Slide Block (back) (2)
1628C	24902	Feed Bar Slide Block (back) Nut
17022	24902	Feed Bar Slide Block (back) Nut Washer ..
164005	24902	Feed Bar Slide Block (front)
164892	24902	Feed (back) Bar with 164010
164017	24902	Feed (back) Bar Connection
164008	24902	Feed (back) Bar Connection Bearing

No.	Plate	Name
164009	24902	Feed (back) Bar Connection Hinge Screw Stud
1671C	24902	Feed (back) Bar Connection Hinge Screw Stud Nut
164010	24902	Feed (back) Bar Connection Hinge Screw Stud Position Pin
164834	24899	Feed (back) Dog Section (left)
164835	24899	Feed (back) Dog Section (right)
1100AL	24899	Feed (back) Dog Section (right) Screw
164836	24899	Feed (back) Dog complete, Nos. 1100AL, 164834 and 164835
1454F	24899	Feed (back) Dog Screw
164020	24902	Feed (back) Eccentric
	NOTE:	Feed (back) Eccentric No. 164020 is furnished in 6 to 16, 18, 20, 22, 24, 28, 32 and 36 stitches to the inch, unless otherwise stated. No. 164020 (14 stitches to the inch) is supplied regularly.
164006	24902	Feed (front) Bar with 164010
164007	24902	Feed (front) Bar Connection
164018	24902	Feed (front) Bar Connection Bearing
164009	24902	Feed (front) Bar Connection Hinge Screw Stud
1671C	24902	Feed (front) Bar Connection Hinge Screw Stud Nut
164010	24902	Feed (front) Bar Connection Hinge Screw Stud Position Pin
164893	-----	Feed (back) and (front) Bars complete, Nos. 164005, 164006, 164007, 164008, 164017, 164018, 164892 and two each 1671C, 164004 and 164009
164837	24899	Feed (front) Dog
1454F	24899	Feed (front) Dog Screw
164020	24902	Feed (front) Eccentric
	NOTE:	Feed (front) Eccentric No. 164020 is furnished in 6 to 16, 18, 20, 22, 24, 28, 32 and 36 stitches to the inch, unless otherwise stated. No. 164020 (14 stitches to the inch) is supplied regularly.
164838	24902	Feed Eccentric Cover
164399	24902	Feed Eccentric Cover Bracket with 164023
157C	24902	Feed Eccentric Cover Bracket Screw
629K	24902	Feed Eccentric Cover Hinge Screw
164401	24902	Feed Eccentric Cover Latch Spring
227J	24902	Feed Eccentric Cover Latch Spring Screw (2)
164023	24902	Feed Eccentric Oil Wick
164839	24902	Feed Eccentric Cover complete, for use with eccentrics of 4 stitches and above Nos. 629K, 164399, 164401, 164838 and two 227J

No.	Plate	Name
164025	24904	Feed Lifting and Knife (movable) Eccentric
164026	24900	Knife (movable)
164027	24900	Knife (movable) Clamp
140050C	24900	Knife (movable) Clamp Screw
164028	24900	Knife (movable) Guard (lower)
164029	24900	Knife (movable) Holder
198J	24900	Knife (movable) Holder Screw
164030	24900	Knife (movable) Holder Screw Bearing
164714	24900	Knife (movable) Lever with 620AL
164715	-----	Knife (movable) Lever 164714 with 132583, 164035, 164136 and 164153
164032	24900	Knife (movable) Lever Bearing
447AL	24900	Knife (movable) Lever Bearing Set Screw (long)
624AL	24900	Knife (movable) Lever Bearing Set Screw (short)
164373	24829	Knife (upright) Housing Cover and Presser Bar (upright) Housing with 1259AL
	NOTE:	When ordering No. 164373 finish required, either Gray or Black must be specified.
50073J	24829	Knife (movable) Lever Cover and Presser Bar (upright) Housing Screw (2)
164374	-----	Knife (movable) Lever Cover and Presser Bar (upright) Housing complete, Nos. 50060K, 164137, 164138, 164139, 164142, 164143, 164144, 164194 and 164373
	NOTE:	When ordering No. 164374 finish required, either Gray or Black must be specified.
164180	24900	Knife (movable) Lever Guide
164181	24900	Knife (movable) Lever Guide Holder with two 140239AL
164210	24900	Knife (movable) Lever Guide Holder 164181 with 197J, 164177, 164180 and 164182
164182	24900	Knife (movable) Lever Guide Holder Thread Tube
447AL	24900	Knife (movable) Lever Guide Holder Thread Tube Set Screw (frame end)
140239AL	24900	Knife (movable) Lever Guide Holder Thread Tube Set Screw (holder end)
197J	24900	Knife (movable) Lever Guide Screw
132583	24900	Knife (movable) Lever Hinge Pin with 132584
132584	24900	Knife (movable) Lever Hinge Pin Oil Wick
620AL	-----	Knife (movable) Lever Hinge Pin Set Screw
164034	24900	Knife (movable) Lever Hinge Stud
164035	-----	Knife (movable) Lever Hinge Stud 164034 with 164036 and 164269

From the Library of the University of North Carolina at Chapel Hill

PARTS FOR MACHINE No. 246-31

No.	Plate	Name
164036	24900	Knife (movable) Lever Hinge Stud Oil Wick (long)
164269	-----	Knife (movable) Lever Hinge Stud Oil Wick (short)
447AL	24900	Knife (movable) Lever Hinge Stud Set Screw (back)
1143AL	24900	Knife (movable) Lever Hinge Stud Set Screw (top)
164728	24900	Knife (stationary)
164841	24900	Knife (stationary) Clamp Plate with two 904AL
904AL	24900	Knife (stationary) Clamp Plate Adjusting Screw (2)
1313F	24900	Knife (stationary) Clamp Plate Screw (2) ..
797C	24900	Knife (stationary) Clamping Screw
164842	24900	Knife (stationary) Holder
164843	24900	Knife (stationary) Holder 164842 with 797C, 164840, 164841 and two 1313F.....
164042	24900	Knife (stationary) Holder Sleeve
140088E	24900	Knife (stationary) Holder Sleeve Screw
59456	24900	Knife (stationary) Holder Sleeve Screw Washer
164844	24899	Knife (stationary) Holder Wedge
1209X	24899	Knife (stationary) Holder Wedge Screw
164462	24900	Lint Stripper with 735AL
735AL	24900	Lint Stripper Screw
164894	24903	Looper
164046	24903	Looper Carrier with 460AL, 50379F and 164202
164660	24903	Looper Carrier Holder with 1083C, 140393AL and 140596AL
164661	-----	Looper Carrier Holder 164660 with 1324C, 59456 and 164046
1083C	24903	Looper Carrier Holder Clamping Screw
140596AL	-----	Looper Carrier Holder Set Screw (left)
140393AL	24903	Looper Carrier Holder Set Screw (right)
1324C	24903	Looper Carrier Screw
460AL	24903	Looper Carrier Screw Set Screw
59456	24903	Looper Carrier Screw Washer
164048	24903	Looper Driving Shaft
164049	24903	Looper Driving Shaft Bushing (back)
140394E	24903	Looper Driving Shaft Bushing (back) Cap Screw
164293	24903	Looper Driving Shaft Bushing (back) Cap Screw Washer (fiber)
164737	24903	Looper Driving Shaft Bushing (front)
164051	24903	Looper Driving Shaft Crank with 1083C.....
1083C	24903	Looper Driving Shaft Crank Clamping Screw
164052	24904	Looper Driving Shaft Crank Connection with two each 171AL and 140159AL

PARTS FOR MACHINE No. 246-31

No.	Plate	Name
164215	-----	Looper Driving Shaft Crank 164051 with 164052
171AL	24904	Looper Driving Shaft Crank Connection Cap (lower) Screw (2).....
140159AL	24904	Looper Driving Shaft Crank Connection Cap (upper) Screw (2)
1324C	24903	Looper Driving Shaft Crank Key Screw
45057	24903	Looper Driving Shaft Crank Key Screw Washer
164053	24903	Looper Driving Shaft Crank Thrust Bearing
164739	24903	Looper Driving Shaft Oil Ring (rubber)
164740	24903	Looper Driving Shaft Oil Ring Spacer.....
50379F	24903	Looper Set Screw
164202	24903	Looper Stop Pin
164845	24899	Looper Thread Tube
906AL	-----	Looper Thread Tube Set Screw
*164072	-----	Machine Frame
NOTE: When ordering No. 164072 finish required, either Gray or Black must be specified.		
*164846	-----	Machine Frame complete, Nos. 140396E, 164072, 164077, 164849 and three 140395C
164074	24813	Machine Frame Bottom Cover
164075	24813	Machine Frame Bottom Cover Gasket
914C	24813	Machine Frame Bottom Cover Screw (13) ..
*164848	-----	Machine Frame Bracket
*164849	-----	Machine Frame Bracket 164848 with 164207 and two 187E
164207	24905	Machine Frame Bracket Key
187E	24905	Machine Frame Bracket Key Screw (2)
140396E	24905	Machine Frame Bracket Screw (large).....
164077	24905	Machine Frame Bracket Screw (large) Washer (fiber)
164229	24905	Machine Frame Bracket Screw (large) Washer (felt)
140395C	24905	Machine Frame Bracket Screw (small) (3)
164515	24813	Machine Frame Cover (back)
50571J	24813	Machine Frame Cover (back) Screw (long) (2)
914J	24813	Machine Frame Cover (back) Screw (short)
164516	24813	Machine Frame Cover (back) 164515 with 1637K and 140228C
164081	24905	Machine Frame Oil Lead
140088R	24905	Machine Frame Oil Lead Screw
1698J	24905	Machine Frame Oil Lead Screw Nut.....
164082	24905	Machine Frame Oil Plug Bracket
140346AL	24905	Machine Frame Oil Plug Bracket Set Screw
164083	24905	Machine Frame Oil Screen
206J	24905	Machine Frame Oil Screen Screw (3).....
164608	24905	Machine Frame Oil Splash Guard (internal)

PARTS FOR MACHINE No. 246-31

No.	Plate	Name
164605	24905	Machine Frame Oil Splash Guard (internal) Oil Pad
164606	24905	Machine Frame Oil Splash Guard (internal) Oil Pad Fastener
164609	24905	Machine Frame Oil Splash Guard (internal) complete, Nos. 164605, 164606 and 164608
164085	24829	Machine Frame Oil Splash Guard (top)
51023W	24829	Machine Frame Oil Splash Guard (top) Screw (2)
164086	24905	Machine Frame Oil Tube with 164087
447AL	24905	Machine Frame Oil Tube Set Screw
164087	24905	Machine Frame Oil Tube Wick
164089	24904	Machine Frame Rotary Shaft
164090	-----	Machine Frame Rotary Shaft 164089 with 164097, 164215, 164216, 164217 and two each 164093 and 164232
139026	24904	Machine Frame Rotary Shaft Ball Bearing
164092	24904	Machine Frame Rotary Shaft Ball Bearing Housing
51369C	24904	Machine Frame Rotary Shaft Ball Bearing Housing Screw (3)
164093	24904	Machine Frame Rotary Shaft Ball Sleeve (two pieces) (2)
164232	24904	Machine Frame Rotary Shaft Ball Sleeve Guide (2)
164958	24904	Machine Frame Rotary Shaft Bushing (front)
164959	-----	Machine Frame Rotary Shaft Bushing (front) Oil Ring (rubber)
164960	-----	Machine Frame Rotary Shaft Bushing (front) Oil Ring Spacer
1036AL	24904	Machine Frame Rotary Shaft Bushing (front) Set Screw
164095	24904	Machine Frame Rotary Shaft Bushing (intermediate)
51332C	24904	Machine Frame Rotary Shaft Bushing (intermediate) Set Screw
164096	24904	Machine Frame Rotary Shaft Counter- balance with 1036AL
1036AL	24904	Machine Frame Rotary Shaft Counter- balance Set Screw
164097	24904	Machine Frame Rotary Shaft Key
51649C	24904	Machine Frame Rotary Shaft Nut
131056	24904	Machine Frame Rotary Shaft Nut Washer
164098	24904	Machine Frame Rotary Shaft Oil Return and Ball Bearing Grease Retainer
164099	24904	Machine Frame Rotary Shaft Screw Stud ..
164100	24904	Machine Frame Rotary Shaft Thrust Bearing

PARTS FOR MACHINE No. 246-31

No.	Plate	Name
164101	24872	Machine Frame Top Cover
NOTE: When ordering No. 164101 finish required, either Gray or Black must be specified.		
164214	-----	Machine Frame Top Cover 164101 with 330J, 164103 and two 164418
164102	24872	Machine Frame Top Cover Gasket
164103	24872	Machine Frame Top Cover Oil Lead
330J	24872	Machine Frame Top Cover Oil Lead Screw
51369J	24872	Machine Frame Top Cover Screw (3)
164231	24904	Machine Pulley (round and "V" belt) with two 448AL
164071	24904	Machine Pulley Cap
140416X	24904	Machine Pulley Cap Screw
448AL	24904	Machine Pulley Set Screw (2)
164109	24829	Needle Clamp
51720C	24829	Needle Clamping Nut
164110	24829	Needle Driving Shaft with 164118
164275	-----	Needle Driving Shaft 164110 with 51720C, 164109 and 164117
164111	24829	Needle Driving Shaft Bushing
164112	24829	Needle Driving Shaft Bushing Cap
164113	24829	Needle Driving Shaft Bushing Oil Lead
452AL	24829	Needle Driving Shaft Bushing Oil Lead Hole Plug Screw
164114	24829	Needle Driving Shaft Crank with 1083C and two 140596AL
164115	24829	Needle Driving Shaft Crank Ball
1083C	24829	Needle Driving Shaft Crank Clamping Screw
164217	24904	Needle Driving Shaft Crank Connection with 164115 and two each 157AL and 171AL
157AL	24904	Needle Driving Shaft Crank Connection Cap (lower) Screw (2)
171AL	24904	Needle Driving Shaft Crank Connection Cap (upper) Screw (2)
140596AL	24829	Needle Driving Shaft Crank Set Screw (2)
164117	24829	Needle Holder
164118	24829	Needle Stop Pin
164119	24904	Oil Agitator
164120	24905	Oil Cooler with two 164125
164121	24905	Oil Cooler Cover
164123	24905	Oil Cooler Cover 164121 with 164135
164122	24905	Oil Cooler Cover Gasket
145J	24905	Oil Cooler Cover Screw
164124	24905	Oil Cooler Gasket
164125	24905	Oil Cooler Oil Pipe (outlet, left)
164125	24905	Oil Cooler Oil Pipe (outlet, right)
164126	24905	Oil Cooler Oil Tube with 138269 and 164128

For the latest information on Farmall made parts

No.	Plate	Name
164736	-----	Oil Cooler Oil Tube 164126 with 51630 and 164127.....
164127	24905	Oil Cooler Oil Tube Coupling
51630	24905	Oil Cooler Oil Tube Lock Nut
*138269	-----	Oil Cooler Oil Tube Sleeve
164128	24905	Oil Cooler Oil Tube Wick
51139J	24905	Oil Cooler Screw (long) (2)
1324J	24905	Oil Cooler Screw (short)
164135	24905	Oil Cup for filling machine
164607	24900	Oil Deflector
164131	24905	Oil Sight Gauge Background Disc
164132	24905	Oil Sight Gauge Background Disc Gasket
164133	24905	Oil Sight Gauge Window
164132	24905	Oil Sight Gauge Window Gasket
164134	24905	Oil Sight Gauge Window Retainer
164132	24905	Oil Sight Gauge Window Retainer Gasket ..
1485J	24905	Oil Sight Gauge Window Retainer Screw (2)
164136	24900	Presser Bar Bracket
164137	24829	Presser Bar Lifting Bracket with 462AL, 624AL and 51846
51846	24829	Presser Bar Lifting Bracket Roller and Stud
624AL	24829	Presser Bar Lifting Bracket Set Screw (long)
462AL	24829	Presser Bar Lifting Bracket Set Screw (short)
164138	24829	Presser Bar Lifting Lever
164139	24829	Presser Bar Lifting Lever Spring
140228C	24813	Presser Bar Lifting Lever Stop Screw
1637K	24813	Presser Bar Lifting Lever Stop Screw Nut
164350	24900	Presser Bar (swing-out).....
164141	24900	Presser Bar (swing-out) Lifting Screw Stud
1700J	24900	Presser Bar (swing-out) Lifting Screw Stud Nut
164142	24829	Presser Bar (swing-out) Opening Lever.....
50060K	24829	Presser Bar (swing-out) Opening Lever Hinge Screw.....
140510C	24900	Presser Bar (swing-out) Pivot Screw.....
164351	24900	Presser Bar (swing-out) Pivot Screw Lock Washer
51362AL	24900	Presser Bar (swing-out) Pivot Screw Lock Washer Screw
164143	24829	Presser Bar (upright).....
164144	24829	Presser Bar (upright) Spring
164416	-----	Presser Bar (upright) Spring (heavy).....
164352	24899	Presser Foot Body (back)
164508	24899	Presser Foot Body (front).....
164509	-----	Presser Foot Body (hinged) Nos. 164352, 164355 and 164508

No.	Plate	Name
164355	24899	Presser Foot Body Hinge Pin
164850	24899	Presser Foot Chaining-off Finger
164147	24899	Presser Foot Clamping Plate
50225J	24899	Presser Foot Clamping Plate Screw
164517	24907	Presser Foot Hemming Guide for 1/4 in., 3/8 in., 1/2 in., 5/8 in., 3/4 in., 7/8 in., 1 in., 1-1/8 in., 1-1/4 in., 1-3/8 in., and 1-1/2 in., gauges.
		NOTE: When ordering No. 164517 gauge required must be specified. Unless otherwise specified No. 164517 will be furnished in 3/4 in. gauge. Furnished only when ordered.
50225J	24899	Presser Foot Hemming Guide Clamping Screw.....
164510	24899	Presser Foot Hemming Guide Clamping Screw Washer
164851	24899	Presser Foot (hinged) complete, Nos. 164147, 164509, 164510, 164850 and two 50225J
164194	24829	Pressure Regulating Thumb Screw.....
164252	24903	Spreader
164056	24903	Spreader Carrier with 50370AL
164828	24903	Spreader Carrier Connection
164829	-----	Spreader Carrier Connection and Guide Bar Nos. 1700J, 50420AL, 164785, 164786 and 164828
164597	24903	Spreader Carrier Connection Guide Bar Bracket with two 462AL
164785	24903	Spreader Carrier Connection Guide Bar Oil Controlling Screw Seat (Brass)
50420AL	24903	Spreader Carrier Connection Guide Bar Oil Plug Screw
1700J	24903	Spreader Carrier Connection Guide Bar Oil Plug Screw Nut
164786	24903	Spreader Carrier Connection Guide Bar Oil Wick
914C	24903	Spreader Carrier Connection Guide Bar Bracket Screw (left)
1057AL	24903	Spreader Carrier Connection Guide Bar Bracket Screw (right).....
462AL	24903	Spreader Carrier Connection Guide Bar Set Screw (2)
164061	-----	Spreader Carrier Connection Hinge Stud with 1019AL
1443J	24903	Spreader Carrier Connection Hinge Stud Cap Screw
164397	24903	Spreader Carrier Connection Hinge Stud Adjusting Pin
1019AL	-----	Spreader Carrier Connection Hinge Stud Adjusting Pin Set Screw

No.	Plate	Name
132565	24903	Spreader Carrier Hinge Pin
50370AL	24903	Spreader Carrier Hinge Pin Set Screw
164062	24903	Spreader Driving Lever with 1083C and two 140596AL
164830	-----	Spreader Driving Lever 164062 with 1443J, 1700J, 132565, 164056, 164061, 164068, 164397, 164597 and 164829
1083C	24903	Spreader Driving Lever Clamping Screw
140596AL	24903	Spreader Driving Lever Set Screw (2)
164063	24903	Spreader Driving Shaft
164049	24903	Spreader Driving Shaft Bushing (back)
140394E	24903	Spreader Driving Shaft Bushing (back) Cap Screw
164293	24903	Spreader Driving Shaft Bushing (back) Cap Screw Washer (fiber)
164738	24903	Spreader Driving Shaft Bushing (front)
164066	24903	Spreader Driving Shaft Crank with 1083C..
164216	-----	Spreader Driving Shaft Crank 164066 with 164052
1083C	24903	Spreader Driving Shaft Crank Clamping Screw
164052	24904	Spreader Driving Shaft Crank Connection with two each 171AL and 140159AL
171AL	24904	Spreader Driving Shaft Crank Connection Cap (lower) Screw (2)
140159AL	24904	Spreader Driving Shaft Crank Connection Cap (upper) Screw (2)
164067	24903	Spreader Driving Shaft Crank Key
1324C	24903	Spreader Driving Shaft Crank Key Screw ..
45057	24903	Spreader Driving Shaft Crank Key Screw Washer
164053	24903	Spreader Driving Shaft Crank Thrust Bearing
164739	24903	Spreader Driving Shaft Oil Ring (rubber)....
164740	24903	Spreader Driving Shaft Oil Ring Spacer
164068	24903	Spreader Locking Screw Stud
1700J	24903	Spreader Locking Screw Stud Nut
164219	24903	Spreader Position Collar with 904AL
904AL	24903	Spreader Position Collar Set Screw
2102	24872	Tension (heavy) Disc (2)
164155	24872	Tension (heavy) Regulating Thumb Nut
50133C	24872	Tension (heavy) Screw Stud
164156	-----	Tension (heavy) Screw Stud 50133C with 164155
164161	24872	Tension (heavy) Spring
59537	24872	Tension (heavy) Spring Bushing
164158	24872	Tension (heavy) Spring Cover
164162	24872	Tension (heavy) complete, Nos. 59537, 164156, 164158, 164161 and two 2102
2102	24872	Tension (light) Disc (4)

No.	Plate	Name
164155	24872	Tension (light) Regulating Thumb Nut (2)
50133C	24872	Tension (light) Screw Stud (2)
164156	-----	Tension (light) Screw Stud 50133C with 164155 (2)
164157	24872	Tension (light) Spring (2)
59537	24872	Tension (light) Spring Bushing (2).....
164158	24872	Tension (light) Spring Cover (2)
164160	24872	Tension (light) complete, Nos. 59537, 164156, 164157, 164158 and two 2102 (2)..
164285	24872	Tension (looper thread) Thread Guide (left)
164286	24872	Tension (looper thread) Thread Guide (right)
164159	24872	Tension (needle thread) Thread Guide
164418	24872	Tension Thread Eyelet (2)
164091	24903	Thread (looper) Stripper and Take-up with 164555
164163	24761	Thread (looper) Stripper and Take-up Eyelet (adjustable)
1443J	24761	Thread (looper) Stripper and Take-up Eyelet (adjustable) Screw
164555	-----	Thread (looper) Stripper and Take-up Guide Wire
187E	24903	Thread (looper) Stripper and Take-up Screw
17022	24903	Thread (looper) Stripper and Take-up Screw Washer
164164	24761	Thread (looper) Thread Eyelet (movable)
1423J	24761	Thread (looper) Thread Eyelet Screw
164165	24761	Thread (looper) Thread Eyelet (stationary)
1607J	24761	Thread (looper) Thread Eyelet (stationary) Nut
164166	24761	Thread (looper) Tube
624AL	24761	Thread (looper) Tube Set Screw
164167	24761	Thread (looper) Plate with 624AL
164168	24761	Thread (looper) Plate Cover
164206	-----	Thread (looper) Plate Cover 164168 with 164169 and 164170
164169	24761	Thread (looper) Plate Cover Hinge
164170	24761	Thread (looper) Plate Cover Hinge Pin
164171	24761	Thread (looper) Plate Cover Spring (2)
332J	24761	Thread (looper) Plate Cover Spring Screw (2)
896AL	24761	Thread (looper) Plate Screw (2).....
164173	24761	Thread (looper) Plate Thread Bushing
50318W	24761	Thread (looper) Plate Thread Bushing Screw
164174	-----	Thread (looper) Plate complete, Nos. 1423J, 1443J, 1607J, 50318W, 164163, 164164, 164165, 164166, 164167, 164173, 164206 and two each 332J and 164171
164175	24903	Thread (looper) Take-up

No.	Plate	Name
164176	24903	Thread (looper) Take-up Plate
190E	24903	Thread (looper) Take-up Screw (lower)
1443J	24903	Thread (looper) Take-up Screw (upper)
164381	24900	Thread (needle) Controller
164153	24900	Thread (needle) Controller Lever
1443J	24900	Thread (needle) Controller Screw (2)
164177	24900	Thread Eyelet (needle thread)
140239AL	24900	Thread Eyelet (needle thread) Set Screw...
164852	24899	Throat Plate
1094F	24899	Throat Plate Screw
164853	24899	Throat Plate Support with 906AL
164855	-----	Throat Plate Support 164853 with 997X, 1209X, 59456, 140088E, 161205, 164042, 164843, 164844 and 164845
898X	24899	Throat Plate Support Screw

ACCESSORIES

No.	Plate	Name
164203	24906	Feed Eccentric Extractor (not regularly furnished with machine)
164859	24906	Gauge (not regularly furnished with machine)
160725	24906	Oil Container
160727	24906	Oil Container (filled, 5 oz. mfg. oil, light grade, not stainless) Nos. 160725 and 160726
160726	24906	Oil Container Cap
160728	24906	Oil Container Spout, for use when filling Oil Reservoir
164198	24906	Presser Bar Lifting Chain Spring (under table)
26026	24906	Screw Driver
164196	24906	Threader (6)
164204	24906	Tweezers
164197	24906	Wrench (socket)
10875	24906	Wrench (flat) for 51649
164831	24906	Wrench for 1700

BELT GUARD (Adjustable)

No.	Plate	Name
164183	24866	Belt Guard
164199	24866	Belt Guard Bracket (back)
164200	24866	Belt Guard Bracket (front)
51326J	24866	Belt Guard Screw (2)
164201	24866	Belt Guard (adjustable) complete, Nos. 164183, 164199, 164200 and two each 51326J and wood screws 3/4 in. No. 7 F.H.

BLIND STITCH HEMMING ATTACHMENT
(WITH FOLDER) YIELDING TYPE COMPLETE,
NO. 160384, FOR TUBULAR WORK

No.	Plate	Name
160385	24907	Folder for 1/2 in. to 1-1/2 in. Hem, in steps of 1/8 in.
		NOTE: When ordering No. 160385, size of Hem required must be stated.
160383	24907	Folder Bracket

**BLIND STITCH HEMMING ATTACHMENT
(WITH FOLDER) YIELDING TYPE COMPLETE,
NO. 160384, FOR TUBULAR WORK
(Continued)**

No.	Plate	Name
160575	-----	Folder Holder complete, Nos. 3146, 50388J and 160383
50388J	24907	Folder Screw
3146	24907	Folder Screw Washer
160384	24907	Blind Stitch Hemming Attachment (with Folder) complete for 1/2 in. to 1-1/2 in. Hem, in steps of 1/8 in., Nos. 160385 and 160575

NOTE: When ordering No. 160384, size of Hem required must be stated.

CHIP CHUTE

No.	Plate	Name
168198	24866	Chip Chute with four wood screws 3/8 in. No. 6 R.H. Blacked

FINGER GUARD

No.	Plate	Name
164455	24907	Finger Guard
164456	24907	Finger Guard Adaptor
1423J	24907	Finger Guard Screw

NOTE: To be furnished when Wire Hemming Guide No. 164517 is to be used.

FOOT LIFTER PARTS

No.	Plate	Name
6439	24866	Chain, 36 in. to 45 in. with 56864 and 56865
4879	24866	Chain Connecting Link

NOTE: When ordering No. 6439, give length required.

**FOOT LIFTER PARTS
(Continued)**

No.	Plate	Name
56864	24866	Chain Hook (large)
56865	24866	Chain Hook (small)
4881	24866	Treadle
4882	24866	Treadle Shaft
4883	-----	Treadle Spring
4884	24866	Treadle Stand
4885	24866	Treadle complete, Nos. 4879, 4881, 4882, 4883, 4884 and two wood screws 1 in. No. 16 F.H.

MACHINE BASE

No.	Plate	Name
164184	24866	Machine Base with two each wood screws 3/4 in. No. 8 R.H. and 1-1/4 in. No. 6 F.H.
164188	24866	Machine Cushion (large) (2)
164189	24866	Machine Cushion (small) (2)
164190	24866	Machine Pad (felt)
140418E	24904	Machine Screw Stud (back)
657E	24904	Machine Screw Stud (front)

**THREAD UNWINDER NO. 151031
FOR THREE SPOOLS**

No.	Plate	Name
228692	-----	Spool Pin (3)
201528X	-----	Spool Pin Nut (3)
395243	-----	Spool Pin Washer (3)
151023	24764	Spool Rest with 858AL and three each 201528X, 228692 and 395243
150203	24764	Spool Rest Cushion (felt) (3)
858AL	24764	Spool Rest Hub Set Screw
151024	24764	Spool Rest Rod
1122C	24764	Spool Rest Rod Set Screw (2)
151025	24764	Spool Rest Stand with two 1122C and three wood screws 1 in. No. 12 F.H.
151026	24764	Thread Guide (lower)
50311C	24764	Thread Guide (lower) Holder Set Screw ...
151027	24764	Thread Guide (lower) Support with 50311C

THREAD UNWINDER NO. 151031 FOR THREE SPOOLS

No.	Plate	Name
151028	24764	Thread Guide (upper,hollow) (2)
151029	24764	Thread Guide (upper) Holder with four 453AL
453AL	24764	Thread Guide Set Screw (3)
151030	24764	Thread Guide Rod
453AL	24764	Thread Guide Rod Set Screw
151031	24764	Thread Unwinder complete, Nos. 151023, 151024, 151025, 151026, 151027, 151029, 151030, two 151028 and three 150203

THREAD UNWINDER NO. 151163 FOR FOUR SPOOLS

No.	Plate	Name
228692	24867	Spool Pin (3)
228764	24867	Spool Pin
201528X	-----	Spool Pin Nut (3).....
395243	-----	Spool Pin Washer (3)
151023	24867	Spool Rest with 858AL and three each 201528X, 228692 and 395243
228765	24867	Spool Rest with 201254C
150203	24867	Spool Rest Cushion (felt) (4)
858AL	24867	Spool Rest Hub Set Screw
151024	24867	Spool Rest Rod
1122C	24867	Spool Rest Rod Set Screw (2)
201254C	24867	Spool Rest Set Screw
151025	24867	Spool Rest Stand with two 1122C and three wood screws 1 in. No. 12 F.H.
151026	24867	Thread Guide (lower)
50311C	24867	Thread Guide (lower) Holder Set Screw.....
151027	24867	Thread Guide (lower) Support with 50311C
151028	24867	Thread Guide (upper,hollow) (2)
151162	24867	Thread Guide (upper, solid)
151029	24867	Thread Guide (upper) Holder with four 453AL
453AL	24867	Thread Guide Set Screw (3)
151030	24867	Thread Guide Rod
453AL	24867	Thread Guide Rod Set Screw
151163	24867	Thread Unwinder complete, Nos. 151023, 151024, 151025, 151026, 151027, 151029, 151030, 151162, 228764, 228765, two 151028 and four 150203

NUMERICAL LIST OF PARTS

No.	Plate	Name
95XC	24899	Edge Guide (floating) Hinge Screw for 161205
145J	24905	Oil Cooler Cover Screw
157C	24902	Feed Eccentric Cover Bracket Screw
157AL	24904	Needle Driving Shaft Crank Connection Cap (lower) Screw for 164217
171AL	24904	Looper Driving Shaft Crank Connection Cap (lower) Screw for 164052
171AL	24904	Needle Driving Shaft Crank Connection Cap (upper) Screw for 164217
171AL	24904	Spreader Driving Shaft Crank Connection Cap (lower) Screw for 164052
187E	24905	Machine Frame Bracket Key Screw for 164849
187E	24903	Thread (looper) Stripper and Take-up Screw
190E	24903	Thread (looper) Take-up Screw (lower)
197J	24900	Knife (movable) Lever Guide Screw for 164210
198J	24900	Knife (movable) Holder Screw
198XC	24899	Edge Guide Support and Throat Plate.. Guide Screw for 161205
206J	24905	Machine Frame Oil Screen Screw.....
227J	24902	Feed Eccentric Cover Latch Spring Screw for 164839
330J	24872	Machine Frame Top Cover Oil Lead Screw for 164214
332J	24761	Thread (looper) Plate Cover Spring Screw for 164174
335J	24899	Blind Stitch Hemming Attachment Folder Stop Plate Screw for 160574
447AL	24900	Knife (movable) Lever Bearing Set Screw (long)
447AL	24900	Knife (movable) Lever Guide Holder Thread Tube Set Screw (frame end)
447AL	24900	Knife (movable) Lever Hinge Stud Set Screw (back)
447AL	24905	Machine Frame Oil Tube Set Screw
448AL	24904	Machine Pulley Set Screw for 164231
452AL	24829	Needle Driving Shaft Bushing Oil Lead Hole Plug Screw
453AL	24764	Thread Unwinder Thread Guide Set Screw for 151029
453AL	24764	Thread Unwinder Thread Guide Rod Set Screw for 151029
460AL	24903	Looper Carrier Screw Set Screw for 164046
462AL	24829	Presser Bar Lifting Bracket Set Screw (short) for 164137
462AL	24903	Spreader Carrier Connection Guide Bar Set Screw for 164597

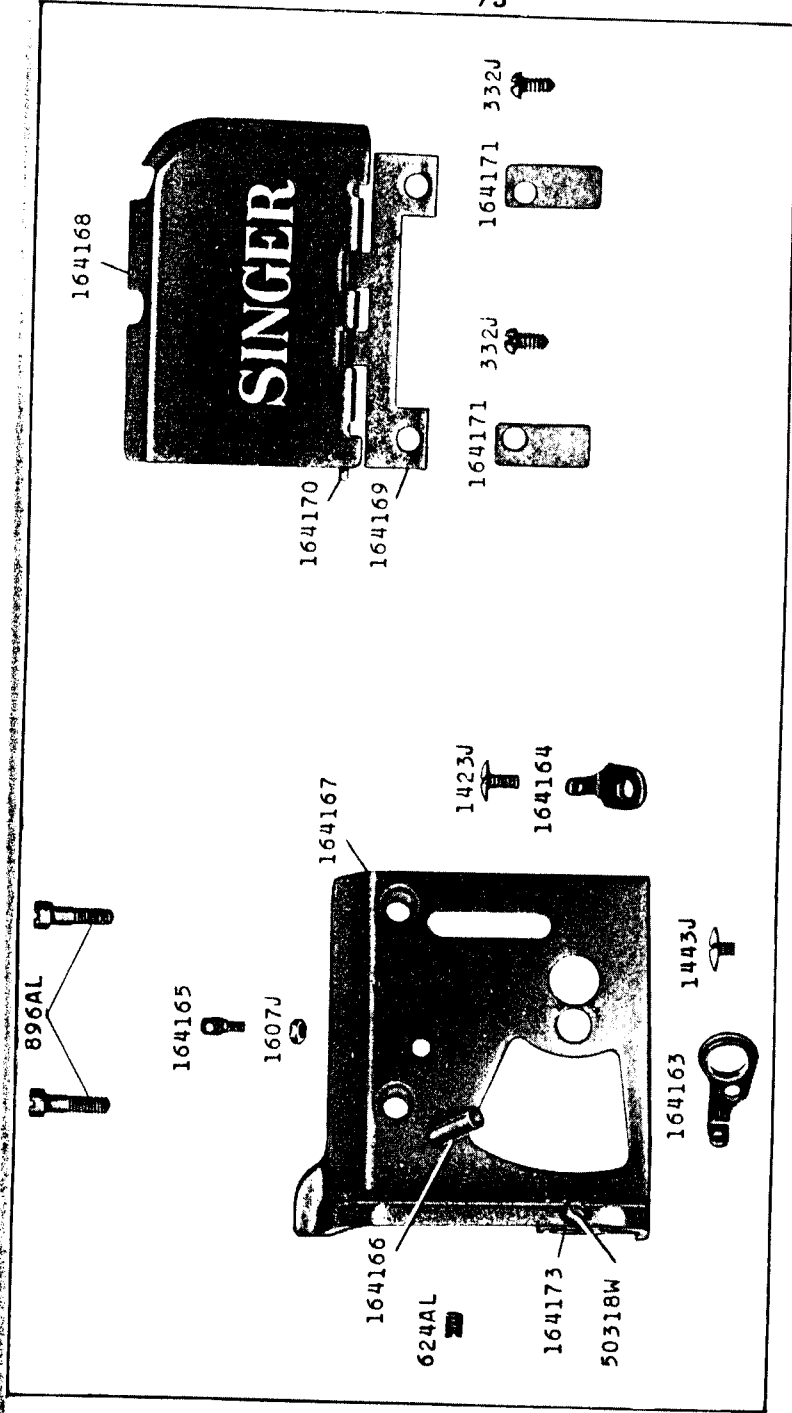

24764 - 1/6

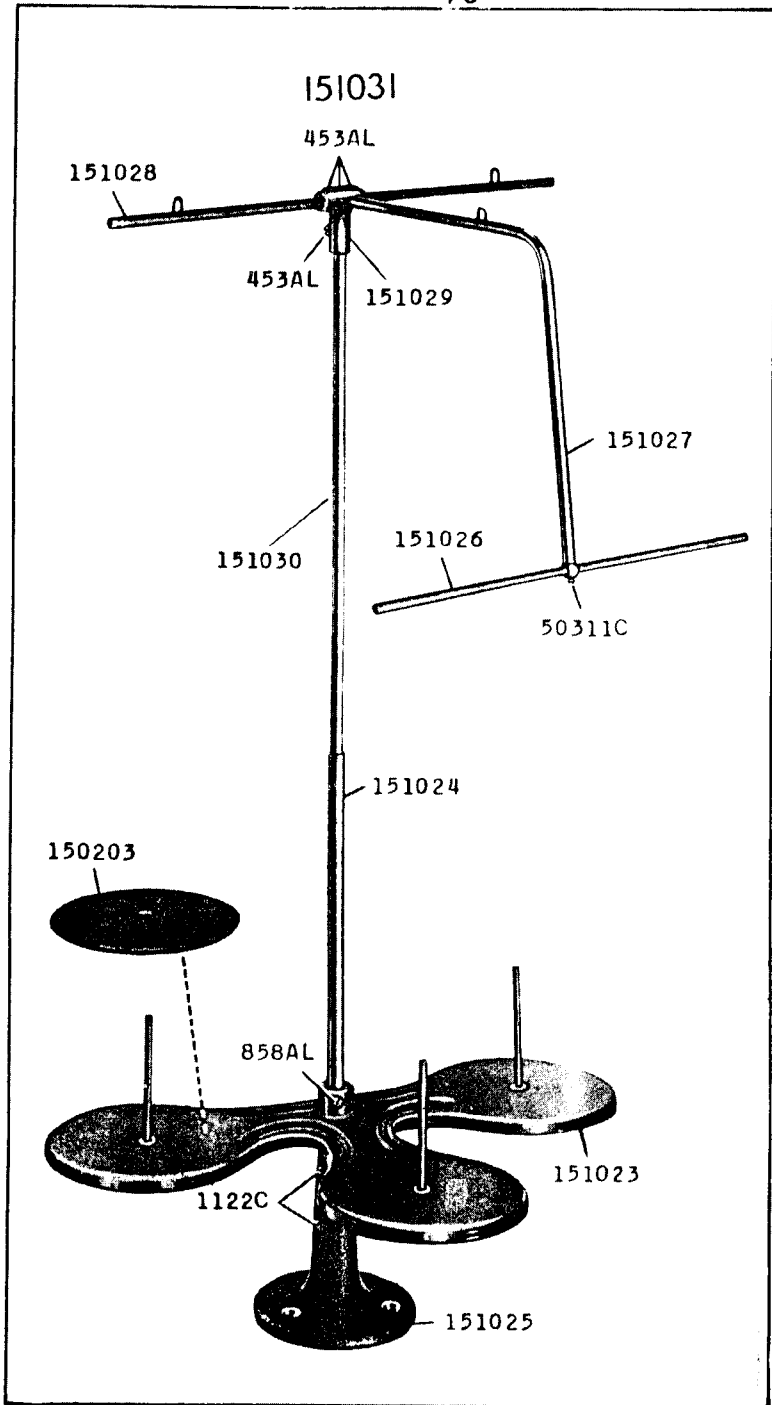

24813-1/3

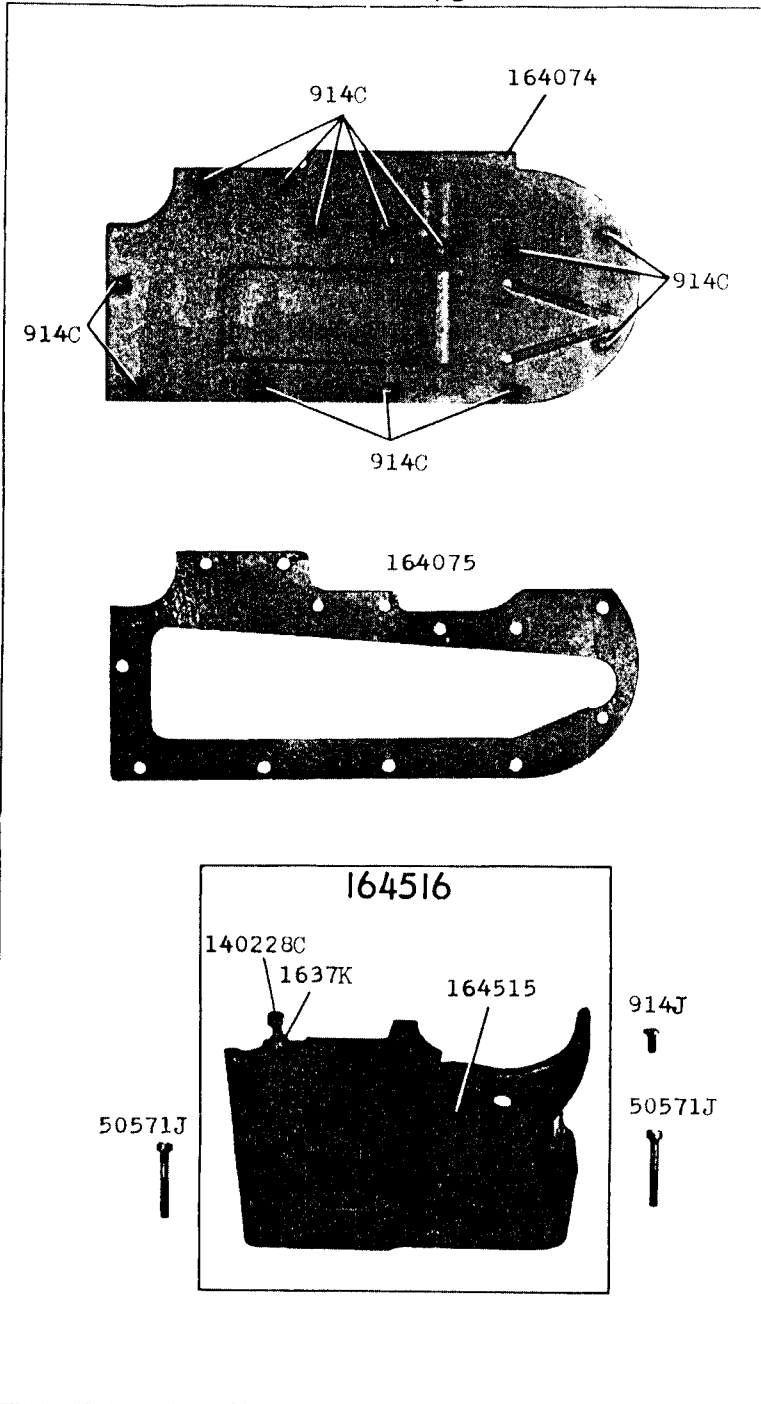

From the library of: Diamond Needle Corp

24829-1/2

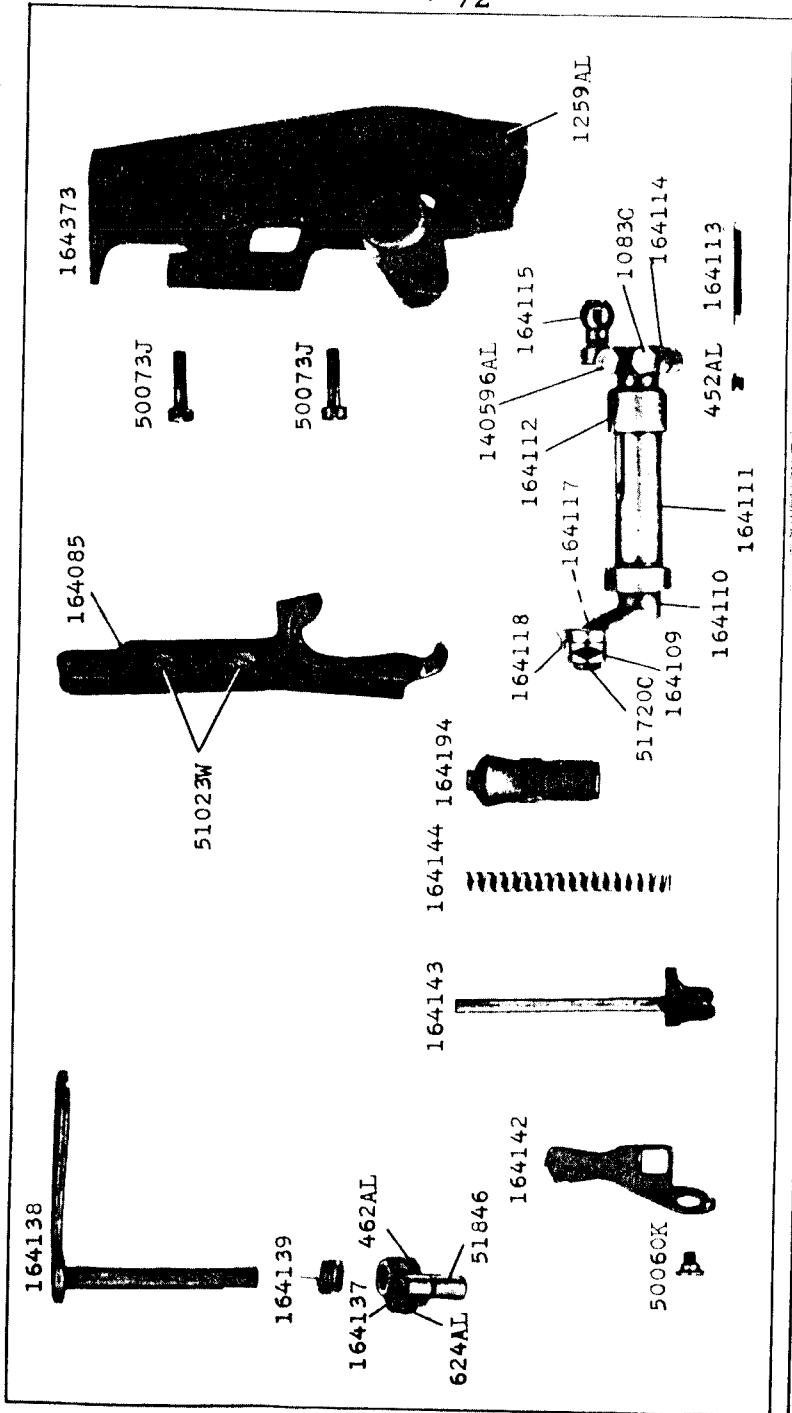

24866 - 1/4

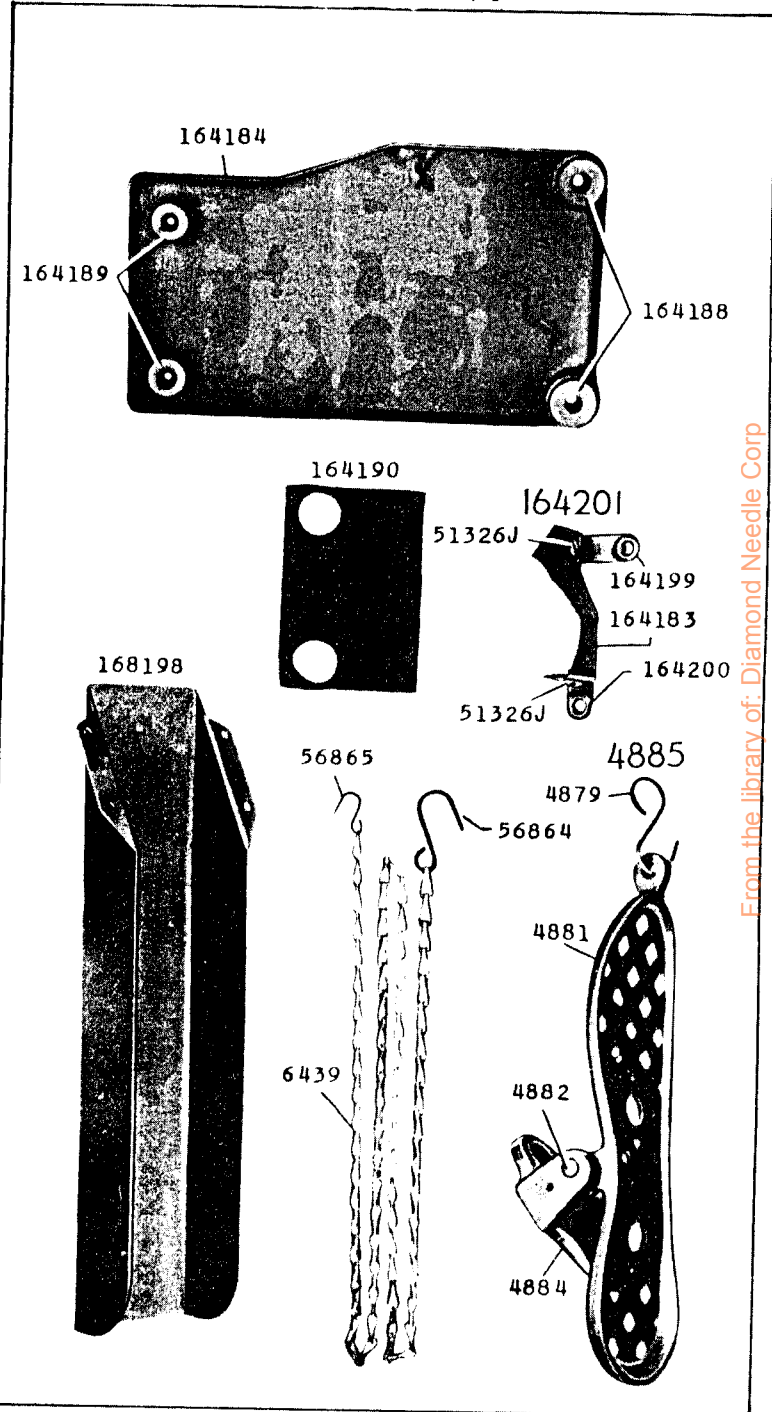

From the library of: Diamond Needle Corp

24867 - 1/6

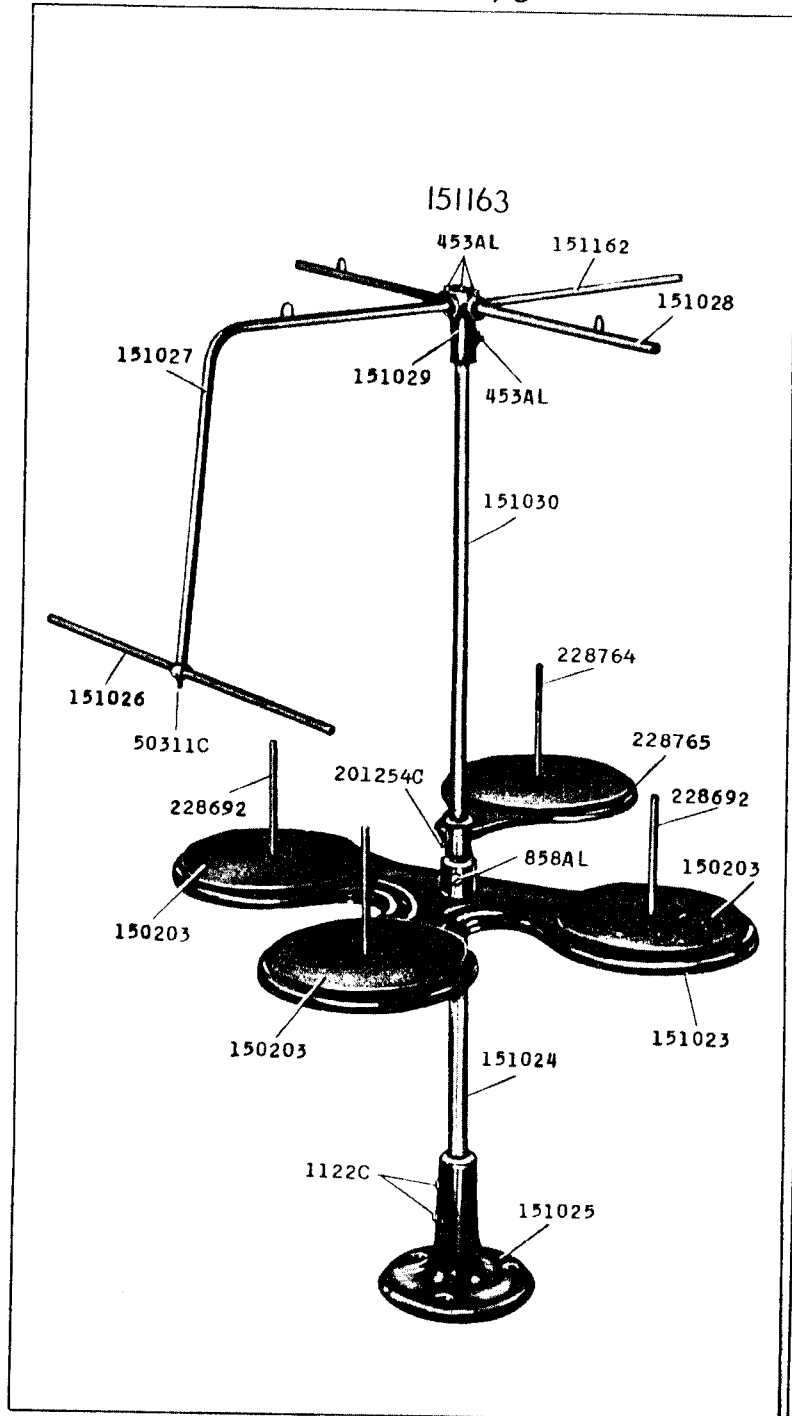

24872-1/3

164162

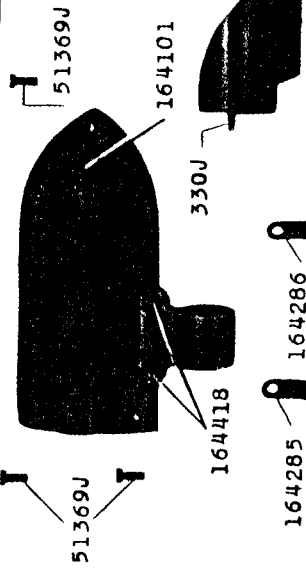
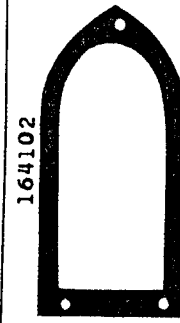
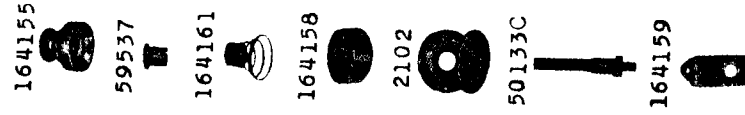

164160

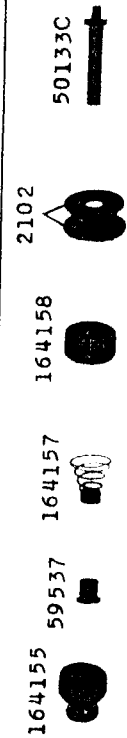

164160

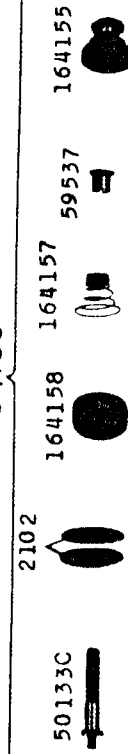

From the library of: Diamond Needle Corp

24899-1/2

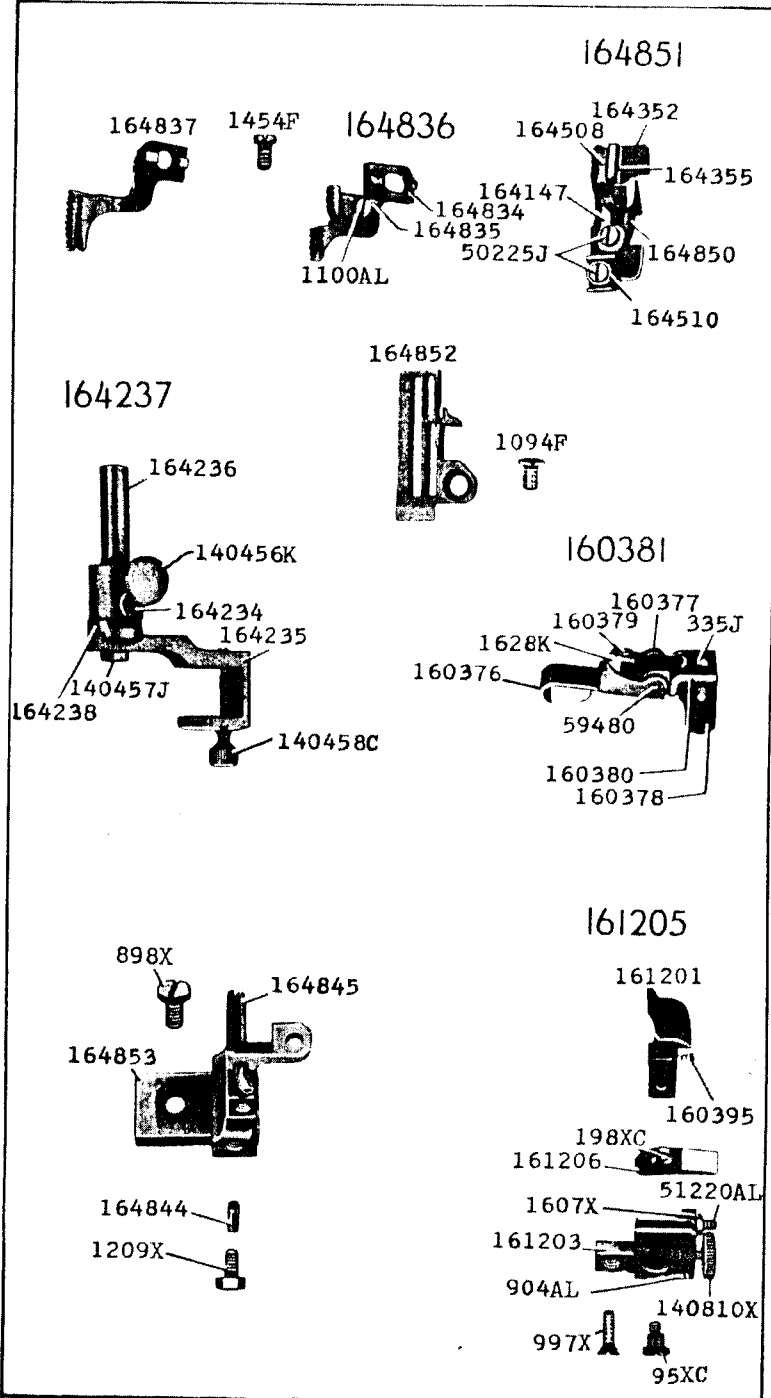

24900-1/2

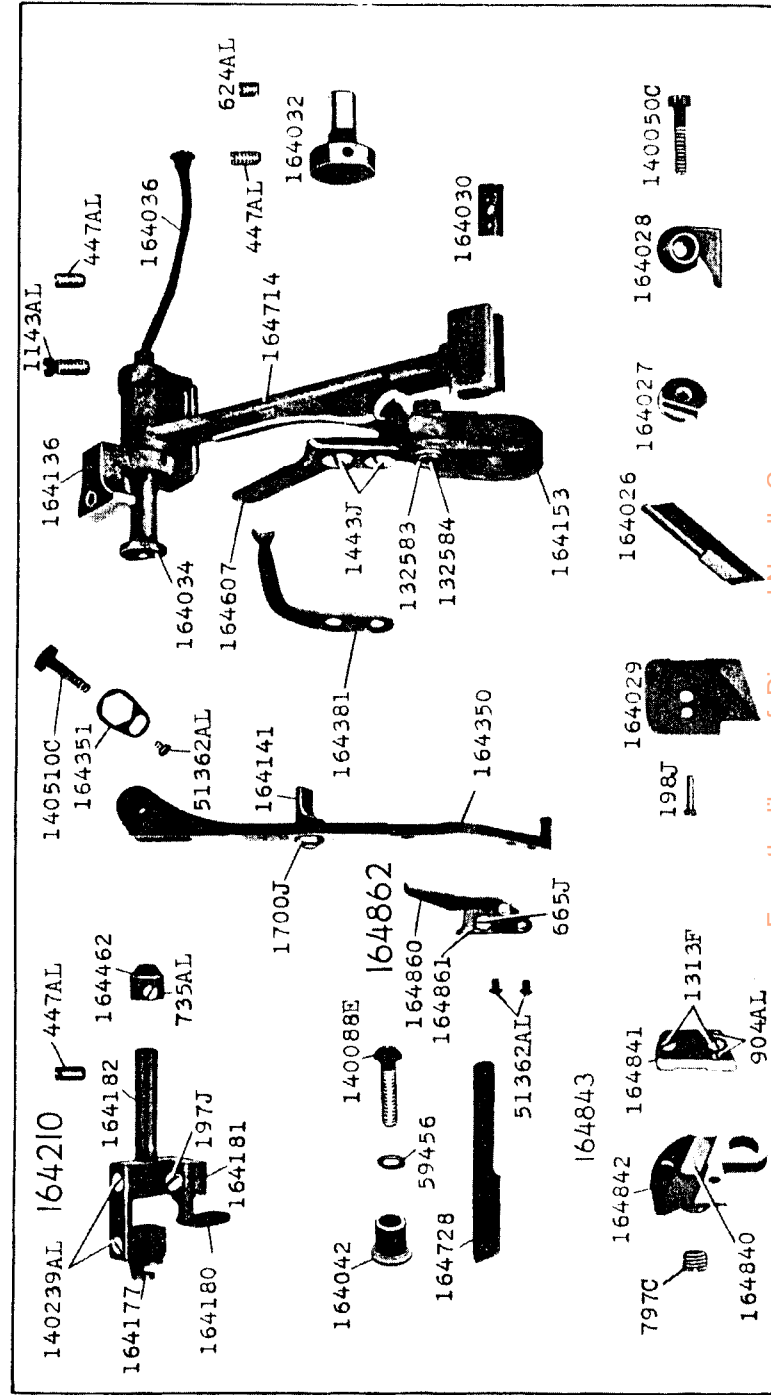

From the library of: Diamond Needle Corp

24901-1/2

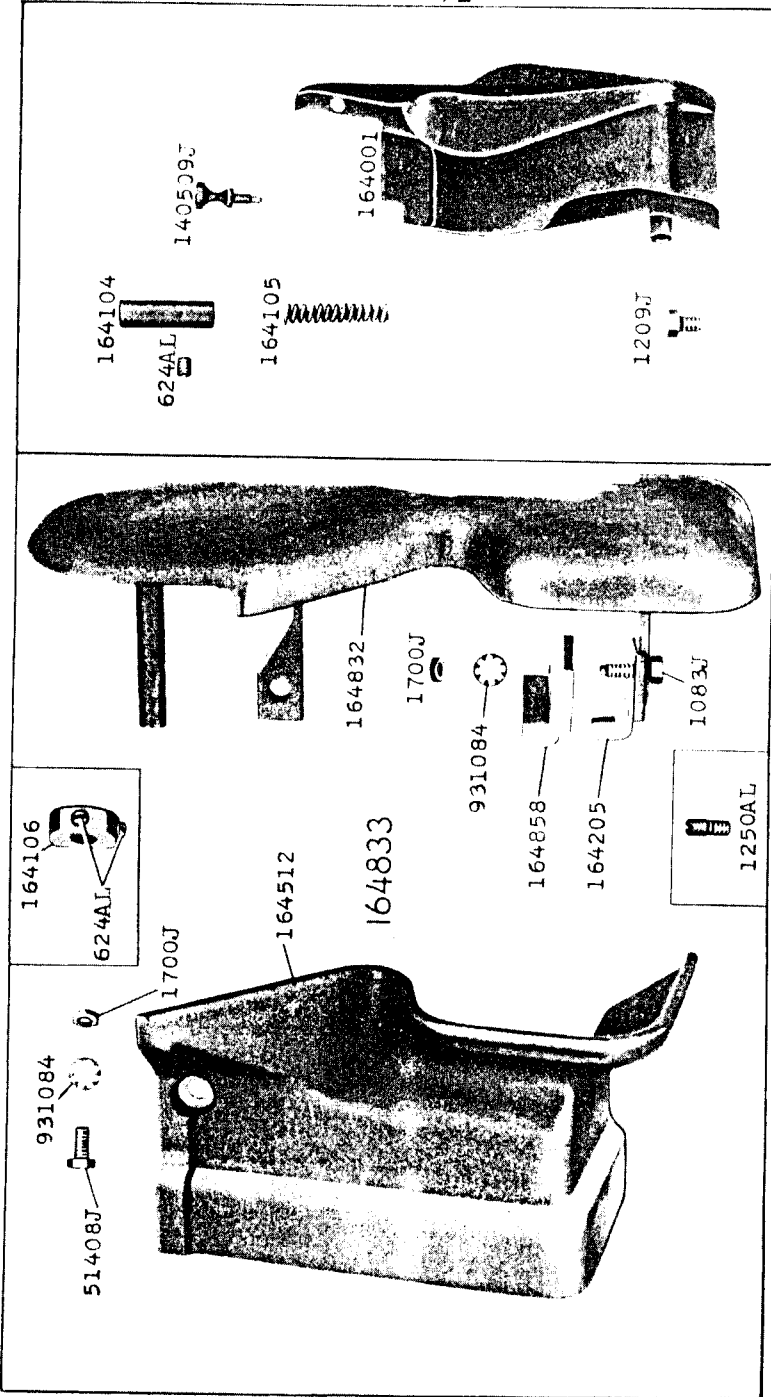

24902-1/2

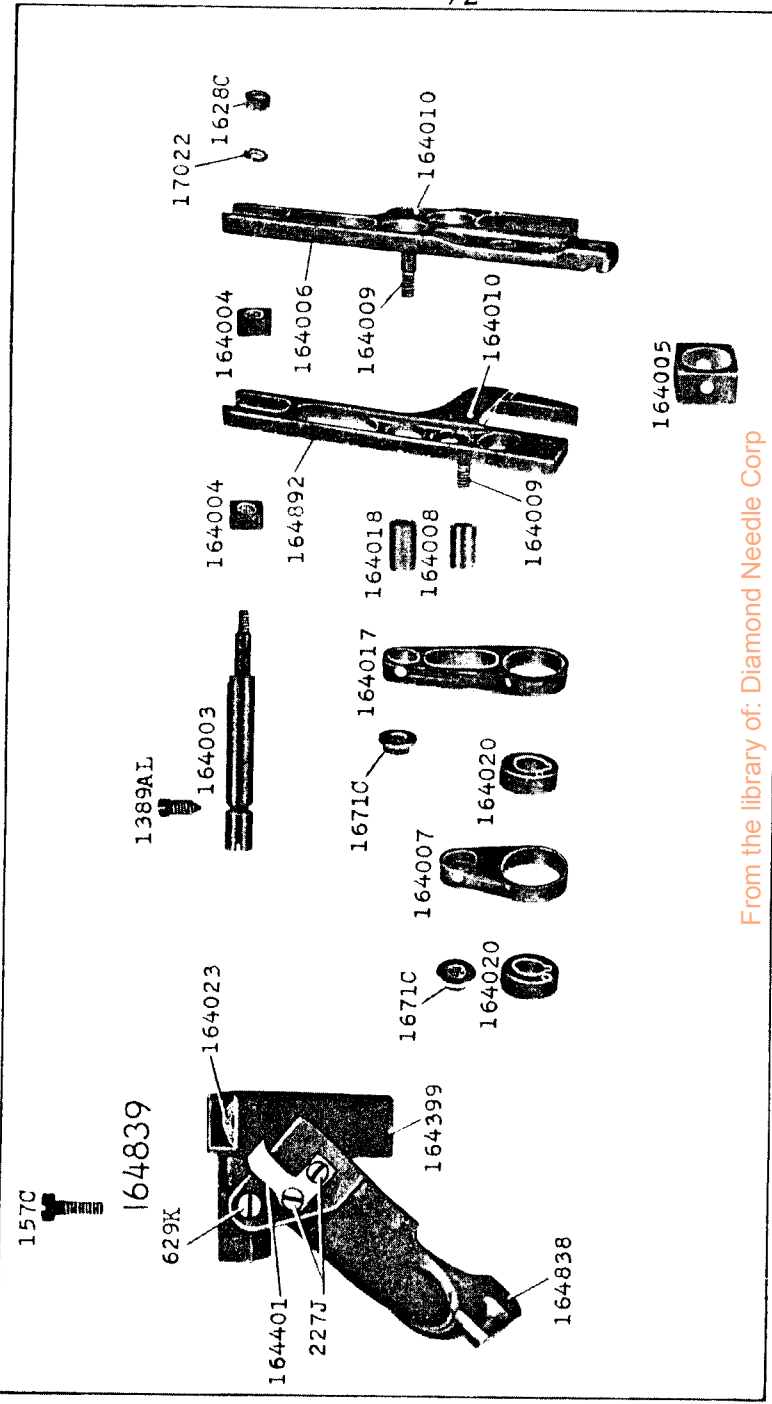

From the library of: Diamond Needle Corp

24903-1/2

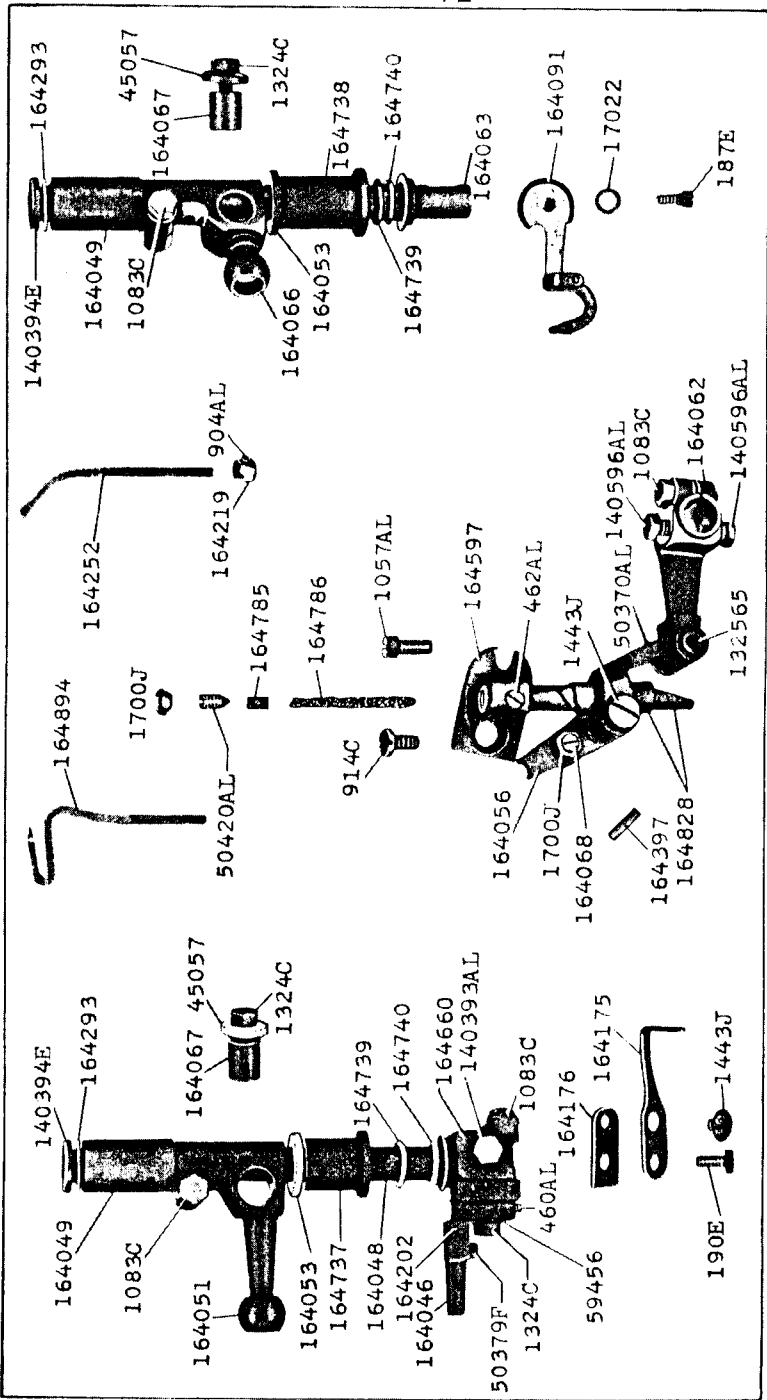

24904-1/3

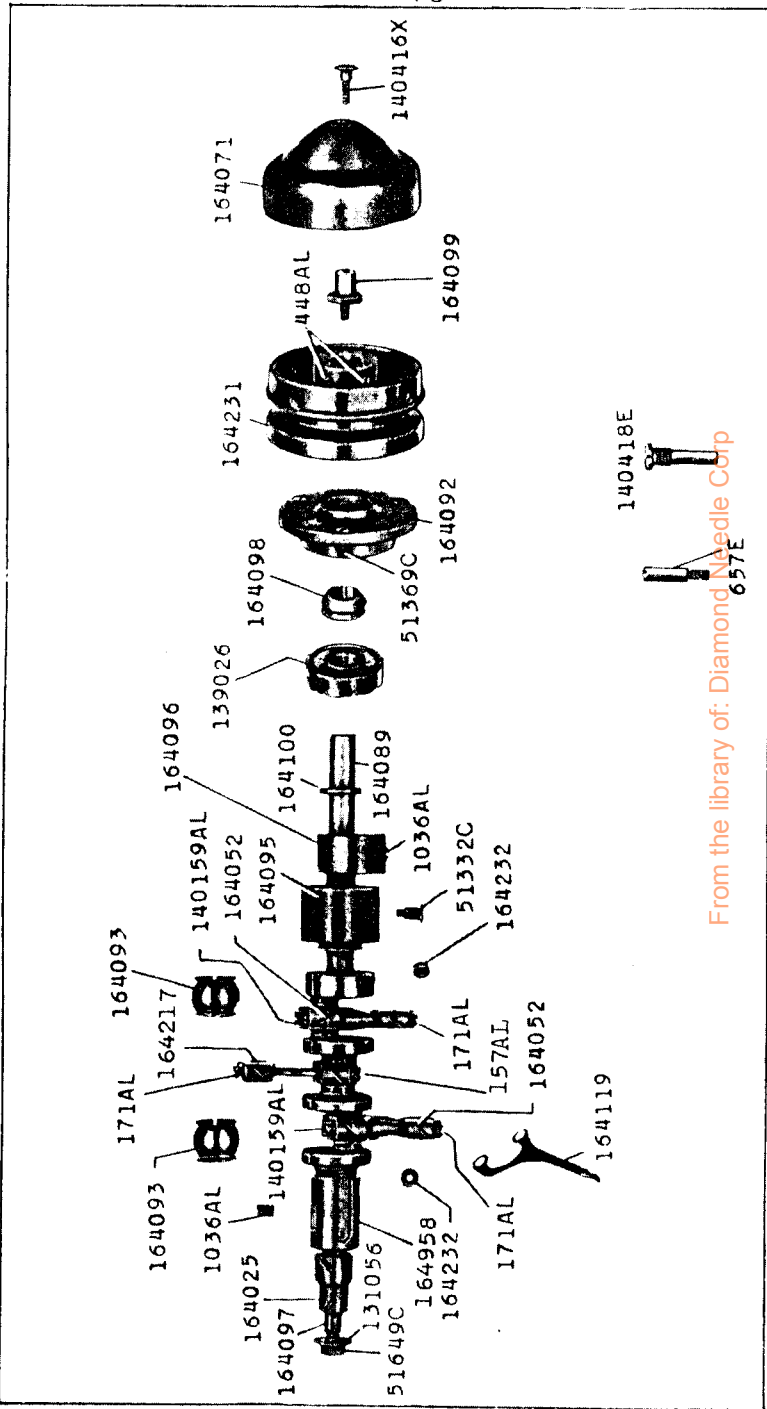

From the library of: Diamond Needle Corp

24905.1/3

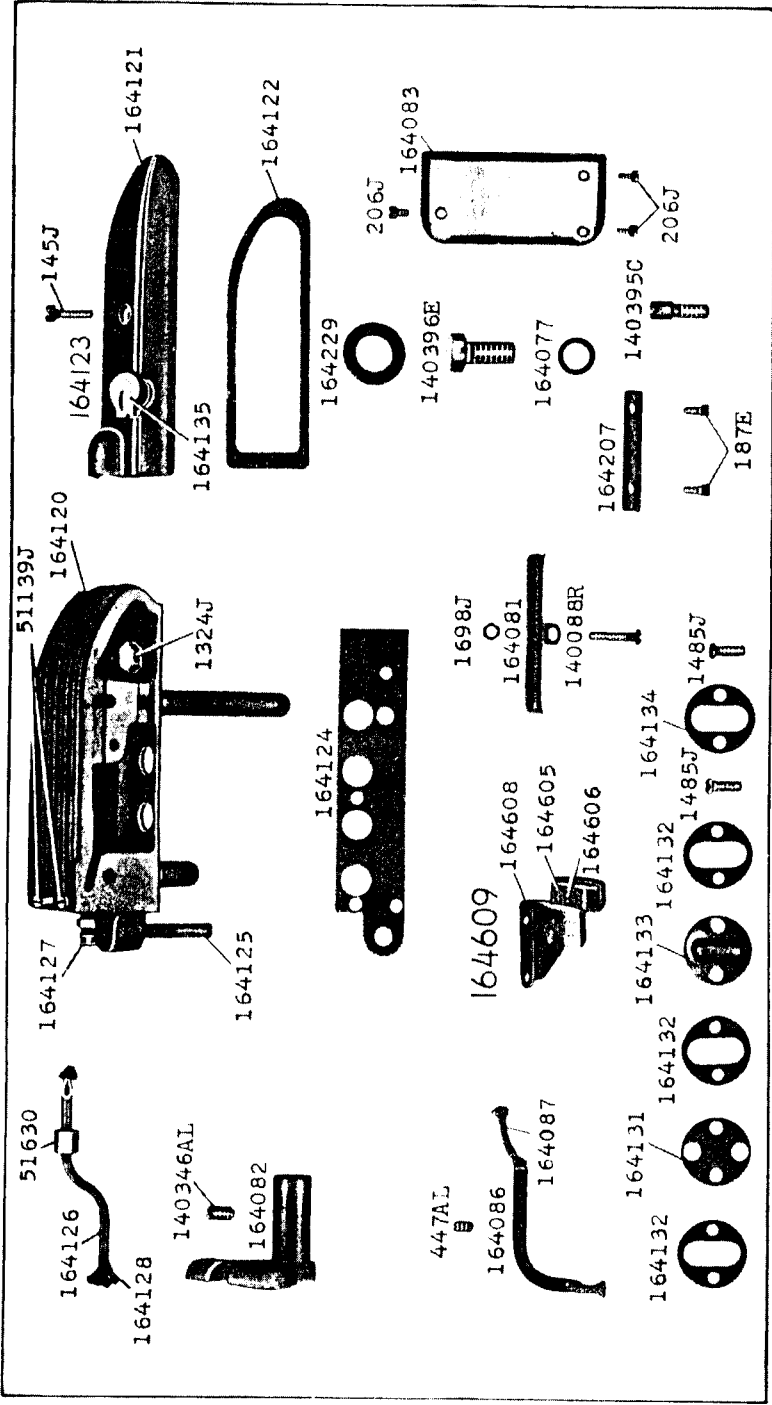

24906.1/2

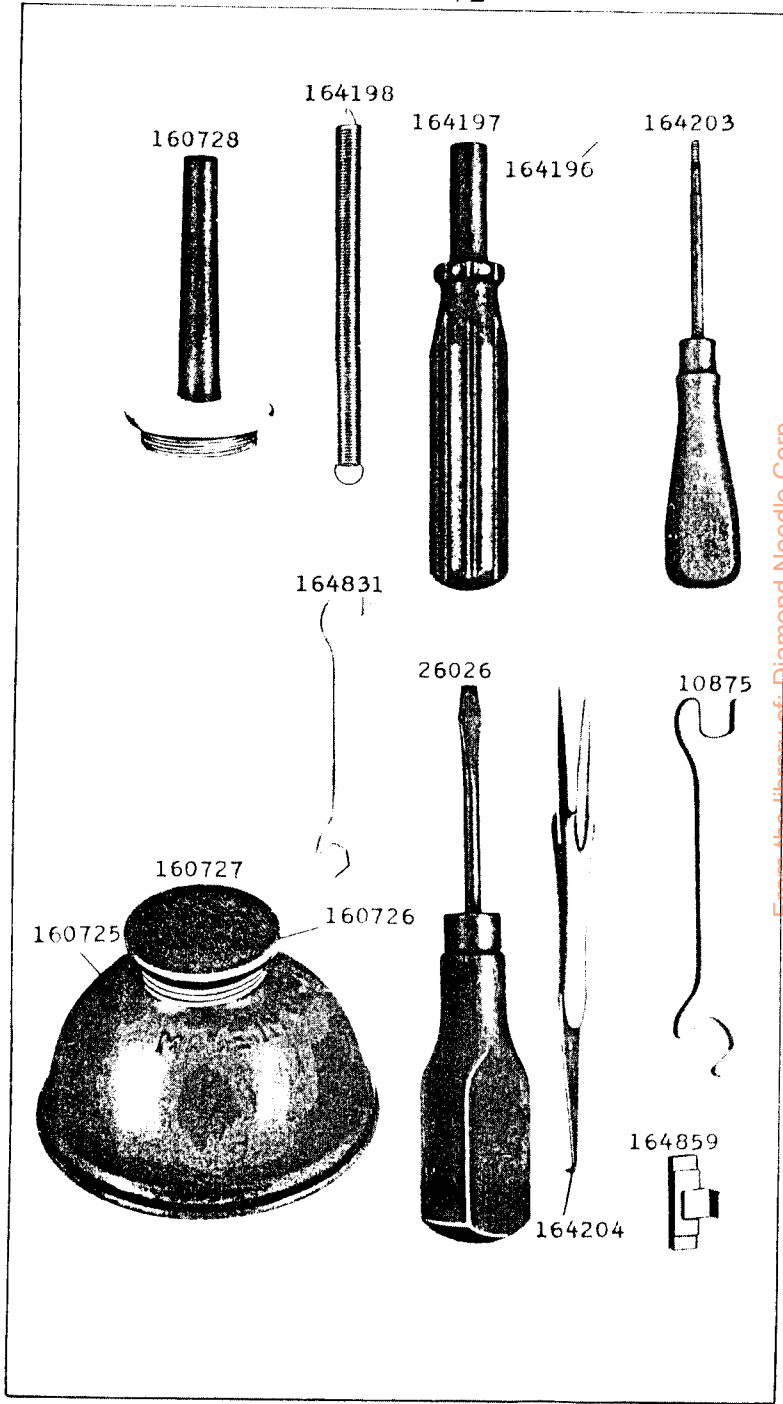

From the library of: Diamond Needle Corp

